

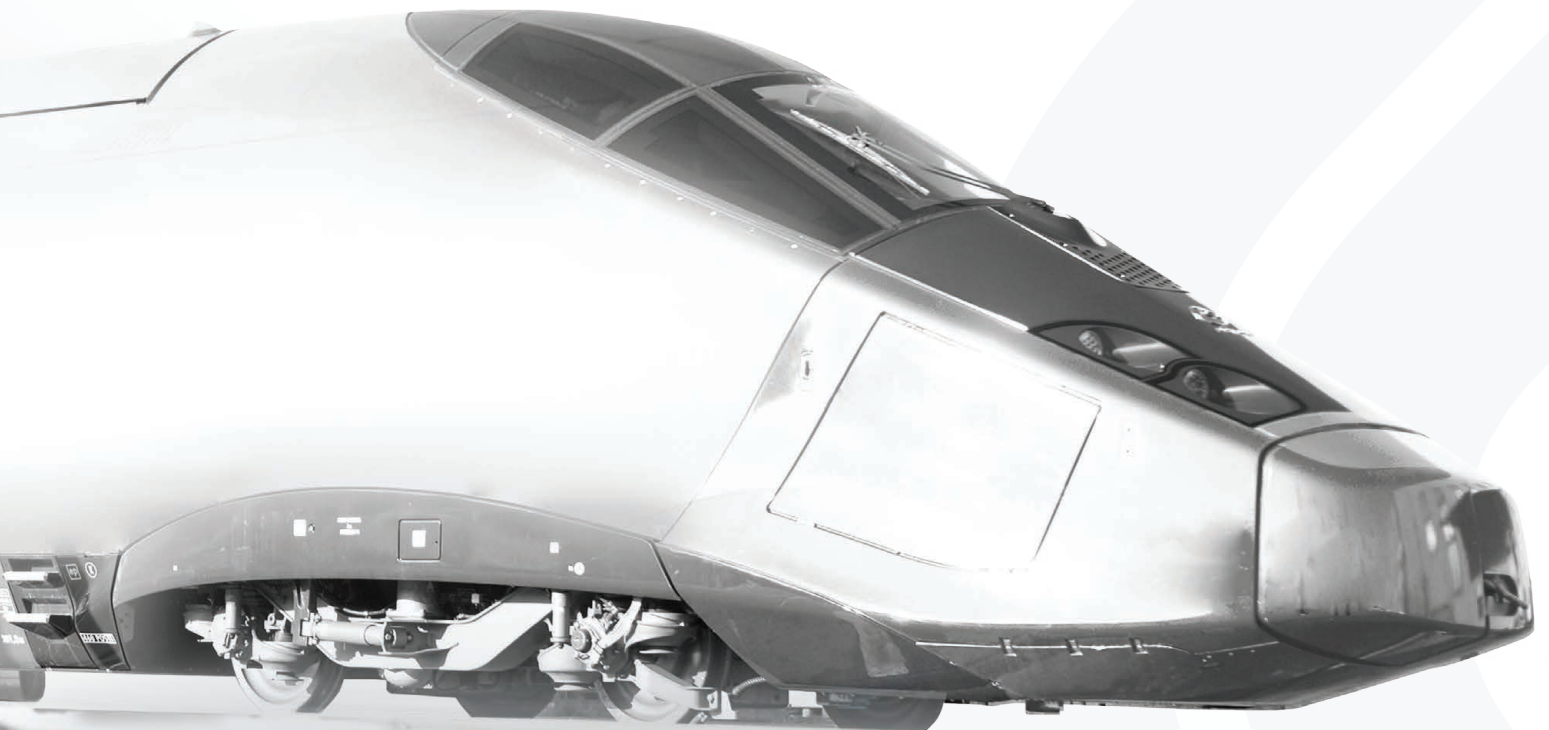

Railway applications couplings



EXPERTISE DRIVEN | CUSTOMER FOCUSED | SUSTAINABLE THINKERS



We connect the world

We are a 75 years old family-owned company specialized in designing and manufacturing high-quality custom-made power transmission products.

Because we believe each transmission challenge is different, we create much more than off-the shelf products: we work hand in hand with our customers to develop the coupling solutions that best fit their specific needs.

Superior product quality is what guarantees our customers' success, it is what enables us to cherish long term partnerships with them. The ESCO quality has been worldly renown for decades and we work tirelessly to raise these standards even further.

We strive to be a significant contributor to the development of effective and clean industrial, transportation and energy supply applications. We want our couplings to power a more sustainable world. We strongly believe that both the future of our economy and the best guarantee for long term return lie in sustainable development. And we want to do our part.



We work with you to design the right solution for your application

If you're reading this, you probably don't need us to describe at length the challenges that the railway industry is facing in this 21st century: urban growth, globalization, consolidation, digitalization, climate change... These are only a few of the mega trends that led players in the sector to design and manufacture trains that are more reliable, safer, faster, less expensive and delivered more quickly than ever.

We have been helping our customers do exactly that for more than 20 years:

- **Quality is our motto, our core competency:** ESCO products are amongst the most reliable in the market; so much so that the main hurdle in our capacity to innovate is the lack of market feedback: our couplings just keep running without issues.
- **Safety is another one of ESCO's strong points.** Our couplings connect the engine to the gearbox: if the coupling fails, the train cannot run. Since they are extremely reliable, our products are also very safe: we have hundreds of thousands of couplings running in the market (some for more than 20 years) and we have never had a train stop because of a faulty coupling!
- **Low lifecycle cost might well be the biggest challenge for ESCO to tackle, but we do work tirelessly to optimize the life time value of our couplings:** fair initial price, smaller footprint (space and weight), longer design life, extended maintenance steps...
- **Short lead time has become a key purchasing criteria for many of our**

customers. We understood this and organised our resources accordingly. The ESCO rail team operates following the "quick response manufacturing" approach: reducing lead time at each step of the value chain is a critical objective.

- **Service is an important part of our business:** to best serve your needs, you can count on our experienced team and advanced testing capability. We are more than happy to assist in performing field interventions, maintenance and repair.

ESCO specializes in the design of custom made couplings. If you cannot find a solution that fits your needs, please contact us: we will work hard to engineer the coupling that fits your application specifications.

Enabling the fastest train journeys

EMU train applications

ICE3 (Germany)



NTV Italo (Italy)



CRH 380-B (China)



Because it has been designed with low life cycle cost in mind and is a breeze to disassemble and maintain, the FTRN coupling is the perfect solution for demanding (high-speed) train applications:

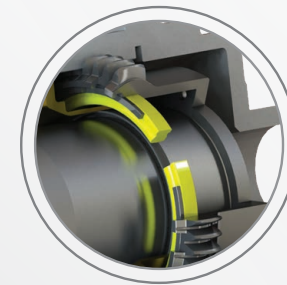

- A proven sealing system associated with factory-filled high-quality lubricant ensures extended maintenance intervals.

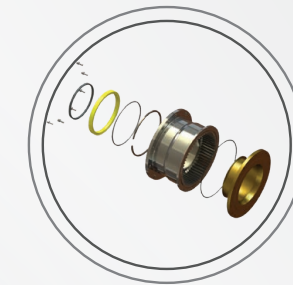

- The major components are manufactured to last the entire life of the train, only a few parts need to be replaced during maintenance.



- Special gear design and patented trust system reduce vibrations, hence decreasing wear and noise.

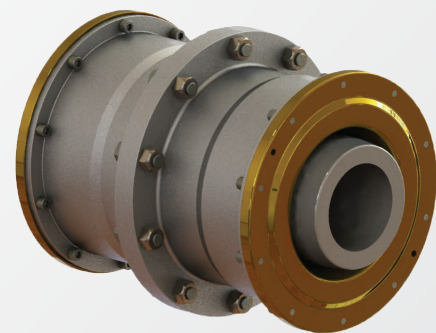

With more than 25 years of existence, the ESCO FTRN coupling is a simple but reliable concept that has stood the test of time.

Coradia, France



Powering your daily commute

EMU metro applications

Guadalajara (Mexico)



Singapore



Delhi (India)



Seoul (South Korea)



Stockholm (Sweden)



Sydney (Australia)



Main FTRN technical specifications:

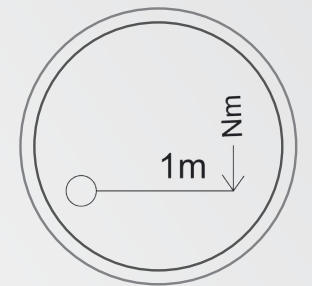
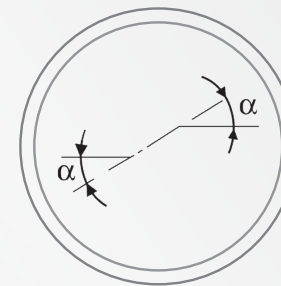
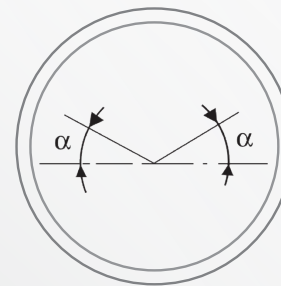

▪ High misalignment capacity (up to 7 degrees angular, 30mm axial)

▪ High torque capacity (up to 20,000 Nm)



▪ High rotation speed potential (up to 7,000 RPM)

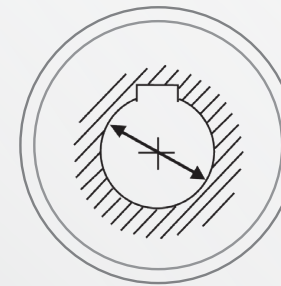

▪ Shaft diameters from 50mm to more than 100mm

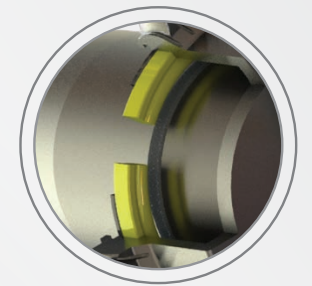

▪ Gear design and thrust system allow for more uniform wear pattern, which makes it the best solutions for metro applications

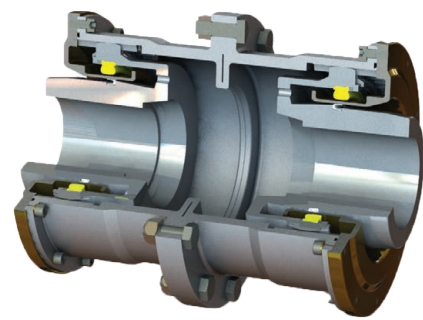

Because each metro application is different, the FTRN coupling can be tailored to fit a wide range of technical specifications



Riyadh (Saudi Arabia)

Driving better urban mobility

Light rail vehicle applications

Nice (France)



Melbourne (Australia)



Tram applications (especially for low floor vehicles) are amongst the most challenging when it comes to technical requirements: confined bogie space, large misalignments, wide torque/speed patterns, harsh vibrations ... ESCO's expertise in both gear and disc technologies ensures we can design the best solution for your application.

Our DTRN and FTRSE product lines answer these requirements perfectly:

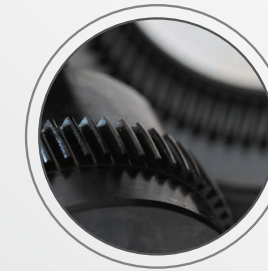

- Special multi-crown gear design, allows for high misalignment capacity (up to 7 degrees angular, 30mm axial)



- Special thick disc design, allows for high torque capacity, infinite life and absence of fretting corrosion

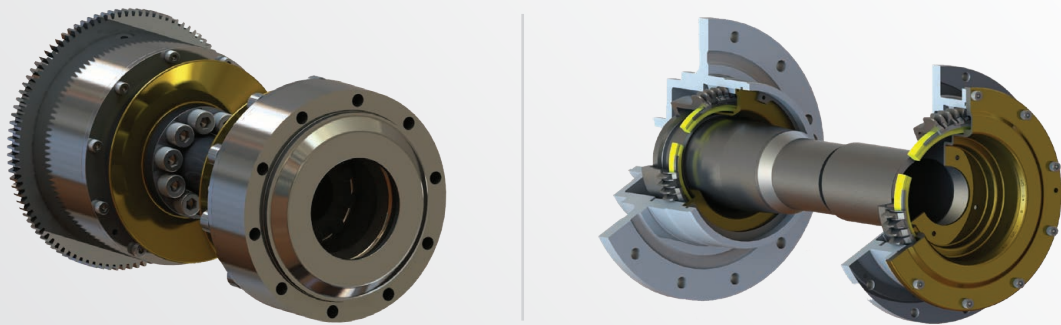

With the increasing pace of urbanization, mobility has become one of the most important challenges for city planners to tackle in the beginning of this 21st century. Reducing congestion will most likely involve building a diversified panel of tightly interconnected transportation modes. In this context light rail vehicles have a bright future ahead of them and ESCO Couplings has the tools to be part of it.

Dubai (UAE)



Engineering the right coupling for your application!

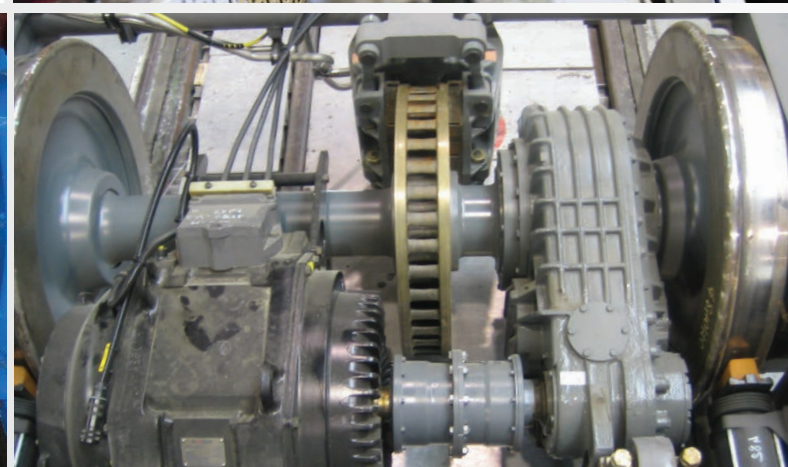
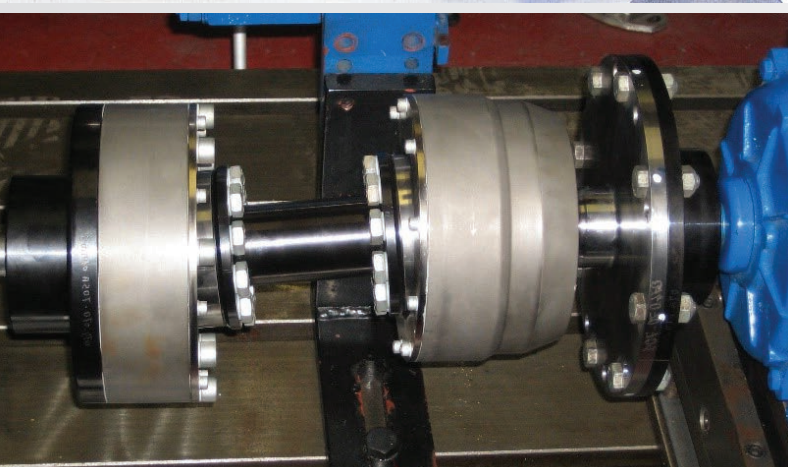
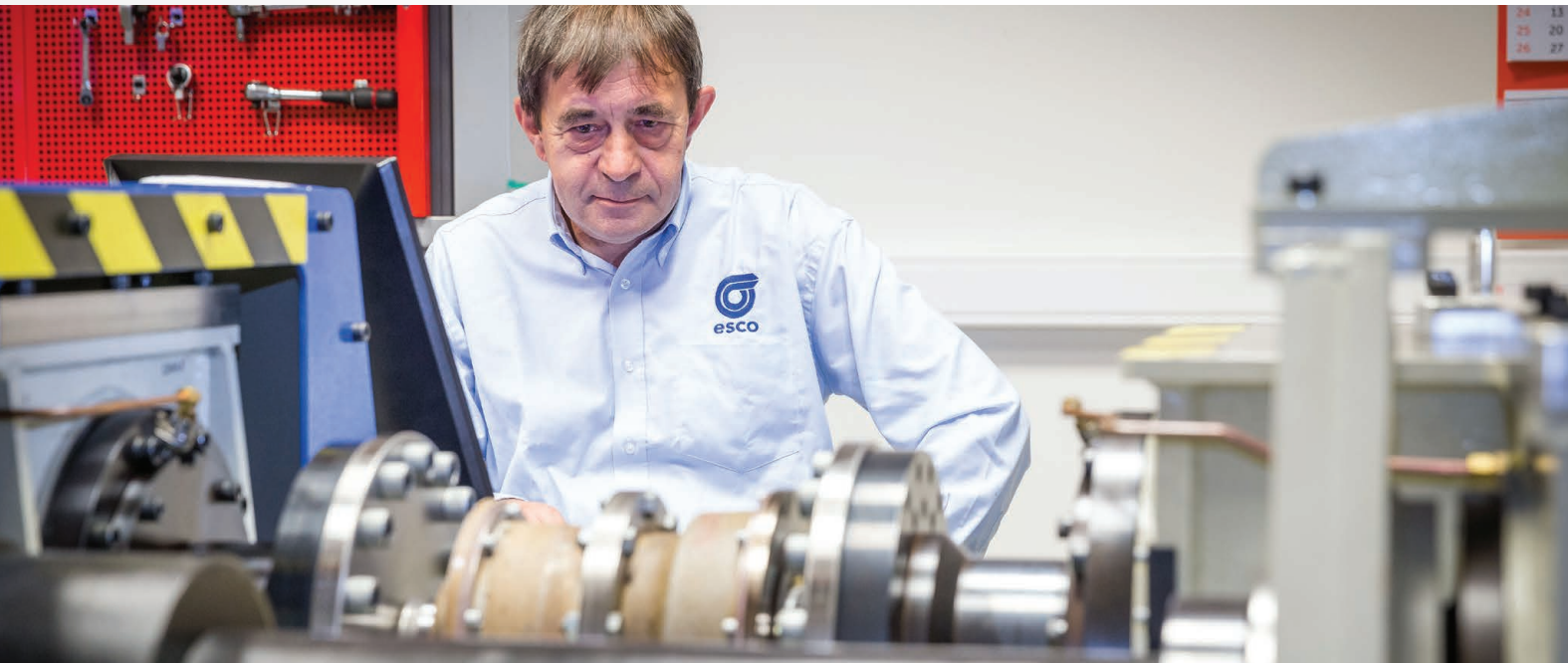

We are confident you will find a coupling that fits your requirements in our product line. In case the drivetrain needs to be protected from unwanted stresses (either mechanical, electrical or both), our couplings can be equipped with the following options:

- Torque limiting devices will protect the gearbox in case of a higher torque than usual (e.g. a short circuit torque). ESCO has three different types of overload systems:

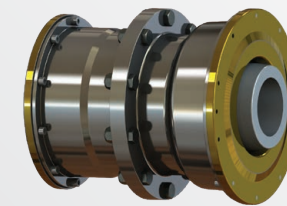

Overload perfectly calibrated in-house to disengage the gearbox from the motor at a specific true threshold



Advanced system that can disengage motor from gearbox permanently

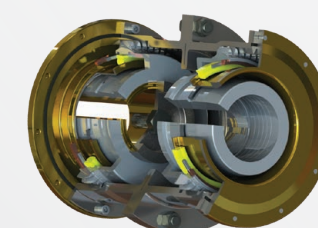

Compact and affordable overload, designed to slip in a specified torque range

- Electrical insulation device will protect the bearings from the gearbox from current leaks which may be originating from the electric motor.

We have spent the last 20 years building our expertise of railway applications. Our engineering team is equipped to design and test a wide range of coupling solutions. Whether you are designing a new magnetic train, retrofitting an old locomotive, building a high-speed train line in the desert... Please contact us, we will design the right coupling for your application.



Much more than products



Our relationship with customers does not stop once couplings are delivered. We have a team of experienced people ready to perform service on the field, repair, inspections, testing... We can also do the maintenance on our couplings for you. This guarantees proper execution of the maintenance instructions and contributes to improving the lifetime of your application.



Once we get involved into a specific sector, we make sure to embrace the quality standards that the market requires. This is why, on top of the [ISO 9001](#) certification, we are also in the IRIS certification process.

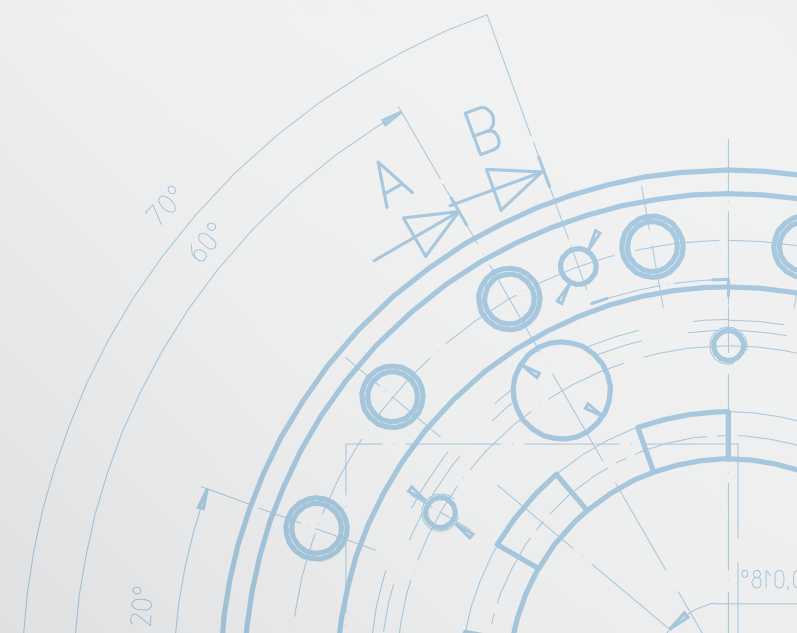
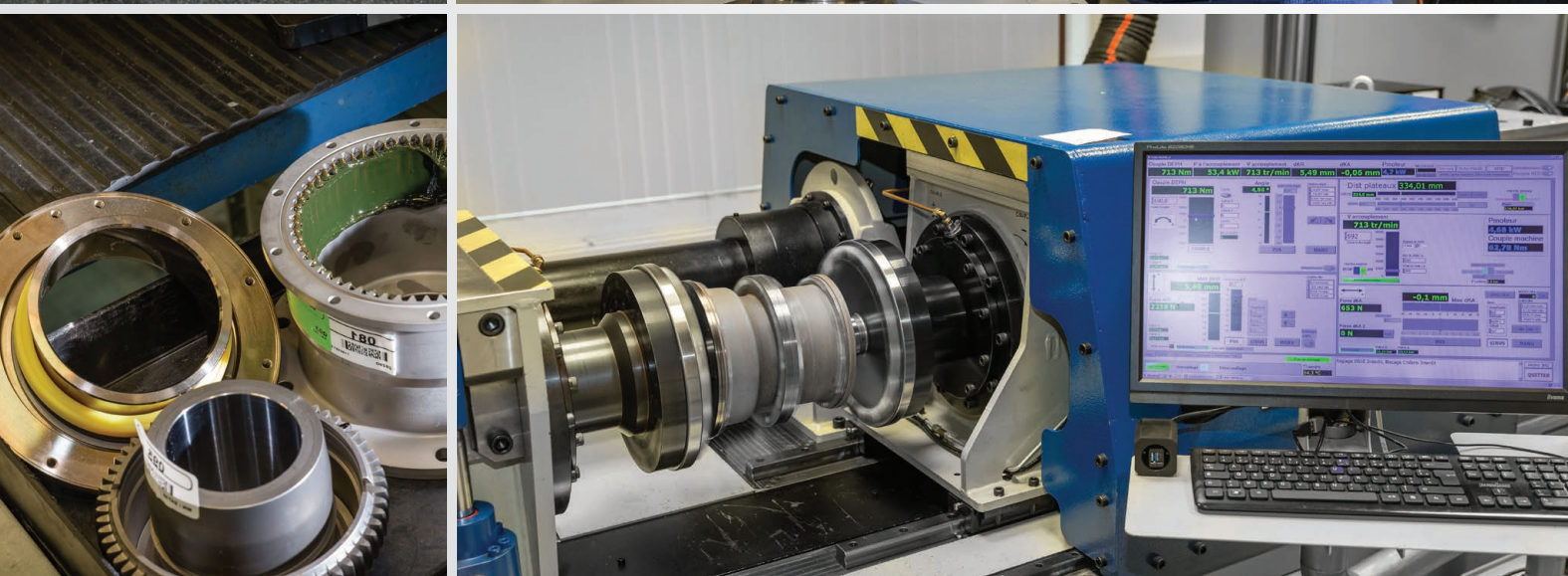

A global footprint, with a family of
9 companies located all across the world



9 offices across the world | **4** manufacturing sites

- ESCO Couplings N.V. Diegem, Belgium
- ESCO Couplings & Transmissions Pvt. Ltd. Bengaluru, India
- ESCO Couplings Ltd. Jinan, China
- André De Decker & Fils S.A. Saintes, Belgium
- ESCO Power N.V. Saintes, Belgium

- Head-office & Manufacturing site
- Manufacturing sites
- Sales offices & Service centres

- ESCO Aandrijvingen B.V. Alphen A/D Rijn, The Netherlands
- ESCO Antriebstechnik GmbH Troisdorf, Germany
- ESCO Drives N.V. Diegem, Belgium
- ESCO Transmissions SAS. Saint Witz, France

Catalogues and brochures

Industry brochures



Corporate brochure



Railway applications



Marine applications



General industry applications



Metals and mining applications



Wind applications

Catalogues



General program



Product catalogue

ESCO Couplings N.V.
Culliganlaan, 3
B - 1831 Diegem
Belgium
Tel +32 (0) 2 715 65 60
Fax +32 (0) 2 720 83 62
e-mail: info@esco-couplings.be
website: www.eskogroup.com

ESCO Aandrijvingen B.V.
Ondernemingsweg, 19
NL - 2404 HM Alphen A/D Rijn
The Netherlands
Tel +31 (0) 172 42 33 33
Fax +31 (0) 172 42 33 42
e-mail: info@esco-aandrijvingen.nl
website: www.esco-aandrijvingen.nl

André De Decker & Fils S.A.
Avenue Ernest Solvay, 48
B - 1480 Saintes
Belgium
Tel +32 (0) 2 355 10 70
Fax +32 (0) 2 355 10 71
e-mail: info@adedecker.com
website: www.adedecker.com

ESCO Drives N.V.
Culliganlaan, 3
B - 1831 Diegem
Belgium
Tel +32 (0) 2 717 64 60
Fax +32 (0) 2 717 64 61
e-mail: info@esco.be
website: www.esco.be

ESCO Antriebstechnik GmbH
Biberweg 10
D - 53842 Troisdorf
Germany
Tel +49 (0) 2241 4807 0
Fax +49 (0) 2241 4807 10
e-mail: info@esco-antriebstechnik.com
website: www.esco-antriebstechnik.de

ESCO Transmissions SAS
Rue de la Ferme Saint-Ladre, 34
F - 95471 Saint-Witz
France
Tel +33 (0) 1 34 31 95 95
Fax +33 (0) 1 34 31 95 99
e-mail: info@esco-transmissions.fr
website: www.esco-transmissions.fr

ESCO Power N.V.
Avenue Ernest Solvay, 48
B - 1480 Saintes
Belgium
Tel + 32 (0) 2 717 64 90
Fax + 32 (0) 2 717 64 91
e-mail: info@escopower.be
website: www.escopower.be

ESCO Couplings Ltd.
2168 Airport Road
CN - 250107 Jinan
China
Tel +86 531 55711596
Fax +86 531 55711599
e-mail: info@esco-couplings.cn
website: www.eskogroup.com

ESCO Couplings & Transmissions Pvt. Ltd.
Plot No. 69-D
Bengaluru Aerospace Park
Unachuru Village Jala Hobli
Bengaluru
India
Tel +91 80 4925 6000
Fax +91 80 4925 6060
e-mail: info@esco-couplings.co.in
website: www.eskogroup.com

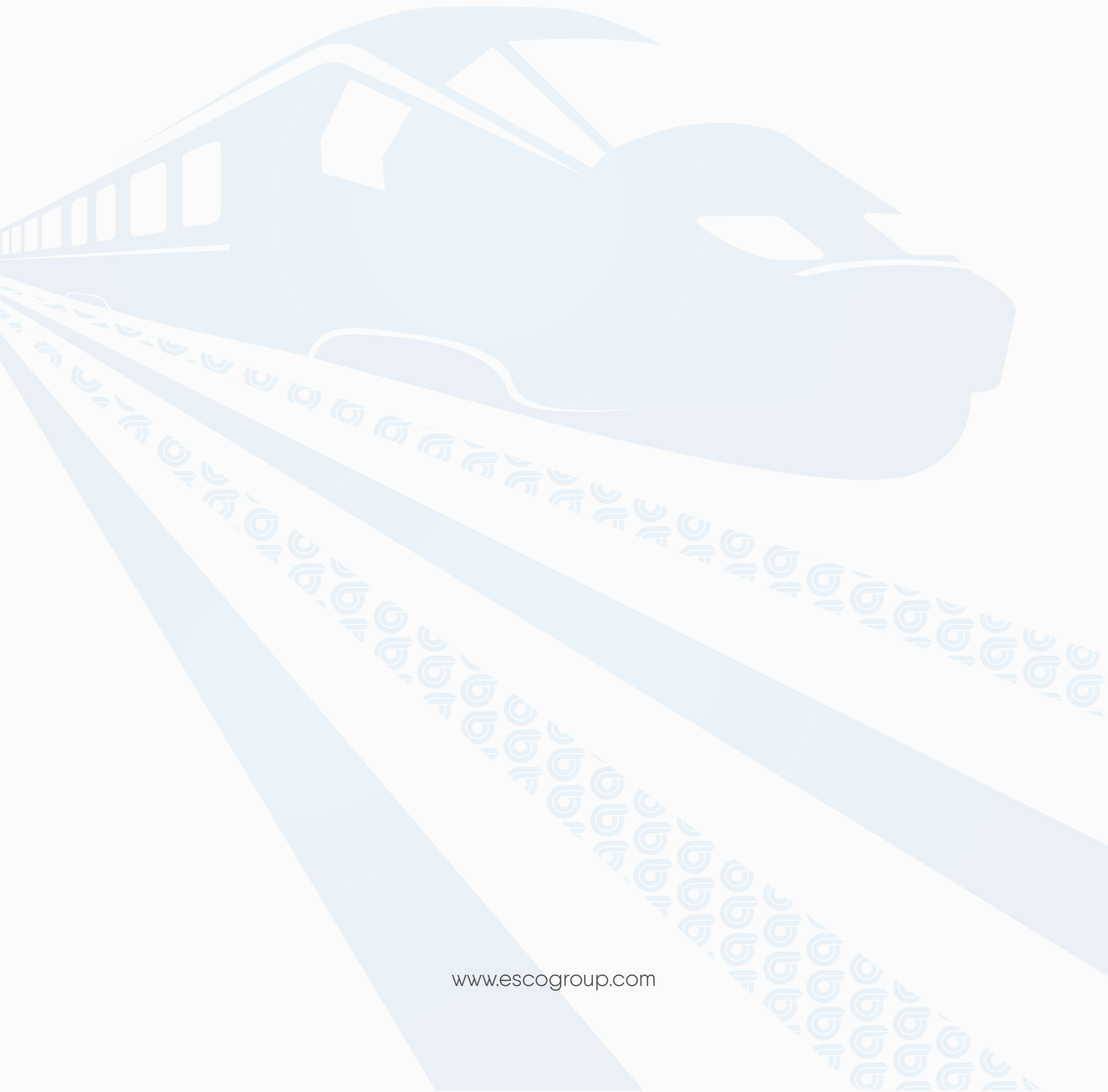

www.escogroup.com